

EQUIPMENT RACK - ADJUSTABLE

ER-03 (OPTIONAL ACCESSORIES)

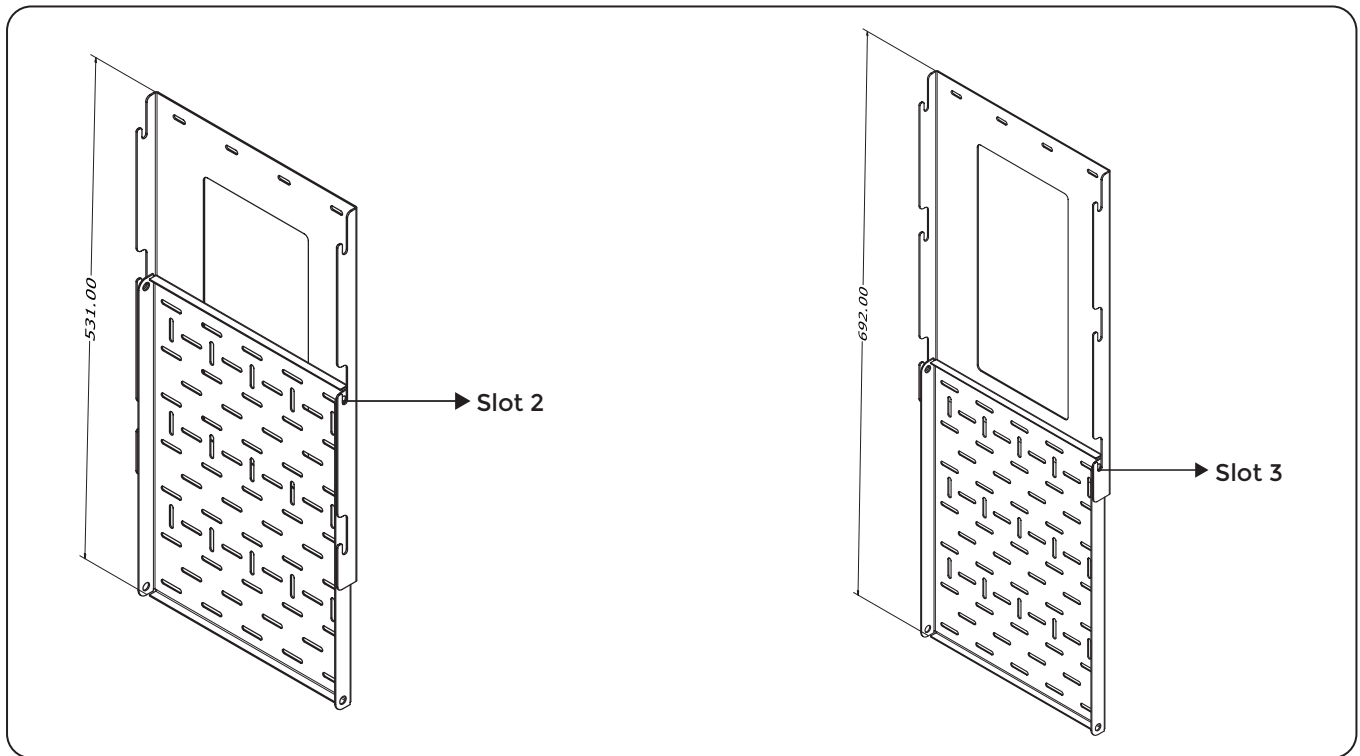
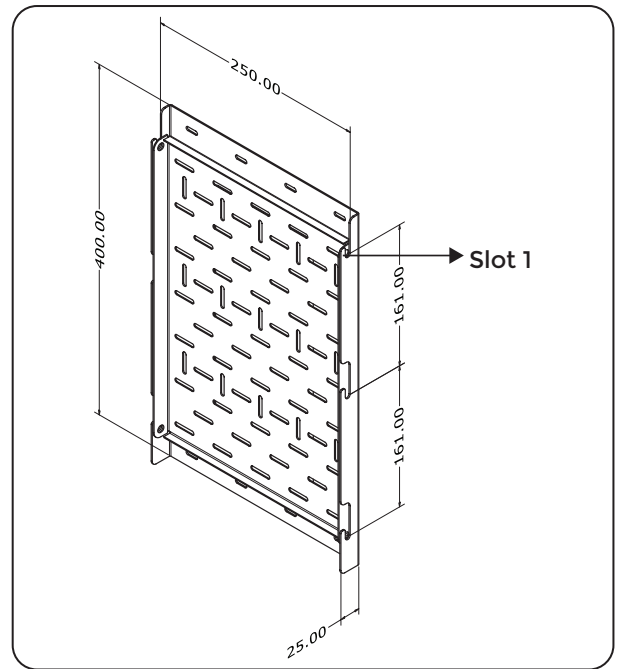

Specification

Model Number	ER-03
Orientation	Portrait
Max.Load	22 lbs (10 kg)
Product Weight	2.1 kg
Shipping Weight	3.1 kg

*Dimensions in mm