

EQUIPMENT RACK - ADJUSTABLE

ER-08 (OPTIONAL ACCESSORIES)

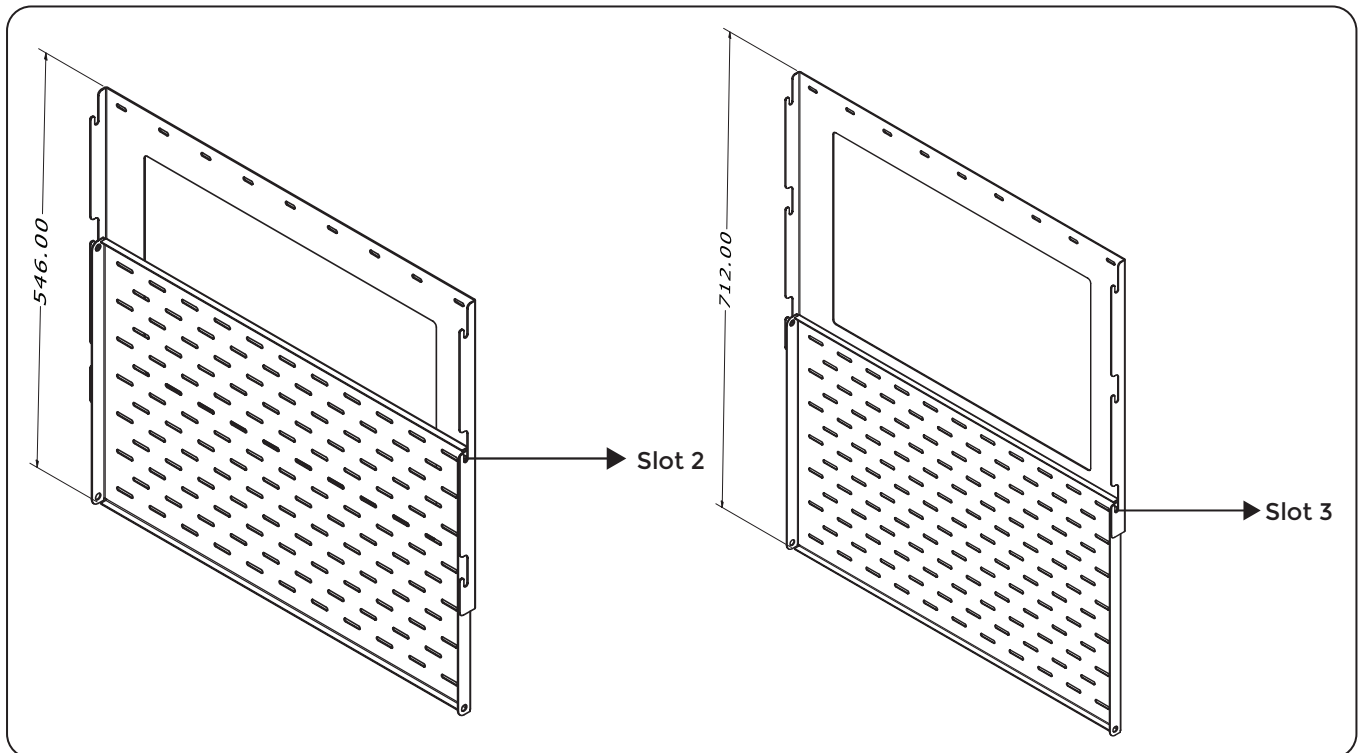
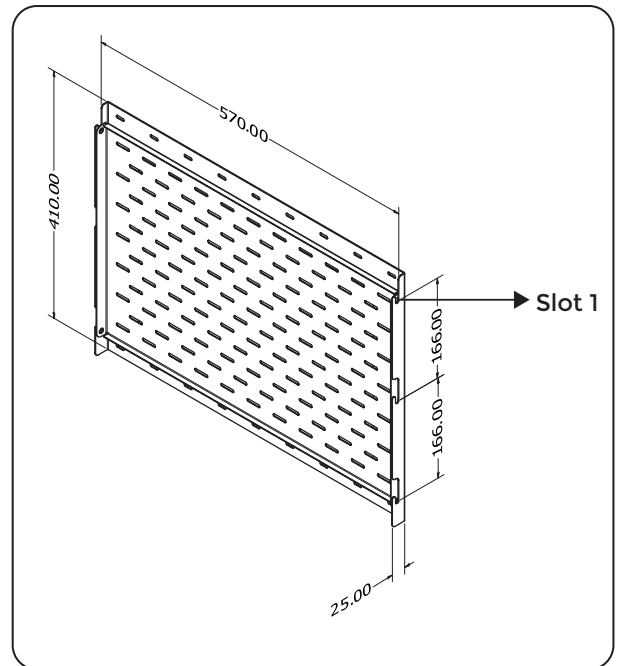

Specification

Model Number	ER-08
Orientation	Portrait
Max.Load	22 lbs (10 kg)
Product Weight	4.2 kg
Shipping Weight	5.2 kg

*Dimensions in mm