

PROJECTOR MOTORIZED MOUNT (STEEL)

LG-SPM200

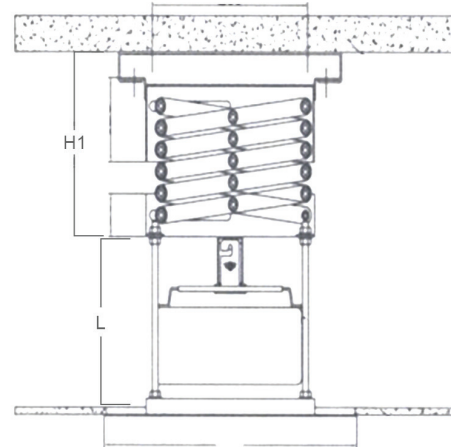

Lift Closed View

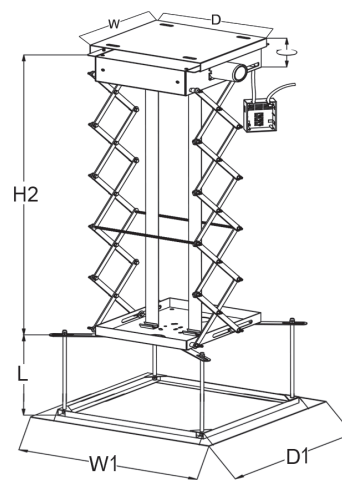

Lift Opened View

Features

- Mount extension is from 200 cm
- The product is made of steel
- High quality motorization
- Quiet and smooth operation
- Maximum weight capacity is 15 kg
- Colours Available : White

Specification

Description	Steel Motorized Projector Lift 200 cm
Ceiling Depth	Min. 800 mm
Max Load	15 kg
Motor	Tubular Motor
Power Supply	220-230 V 50 Hz
Width (W)	320 mm
Depth (D)	320 mm
Bottom Plate Width (W1)	490 mm
Bottom Plate Depth (D1)	490 mm
Lift Size Closed (H1)	310 mm
Lift Size Opened (H2)	2000 mm
Connecting Piece (L)	290 mm
Lift Size Opened Including Fixing (H2 + L)	2290 mm
Suggested Projector Size (W x H x D)	<350 x 200 x 350 mm
Control System	RF
Product Weight	21 kg
Shipping Weight	23 kg
Shipping Dimension (L x W x H)	530 x 530 x 350 mm